

Robot Programming with ROS

5. Sensors

Nils Leusmann, Arthur Niedźwiecki, Stefan
Eirich
16th Nov. 2023



Overview

- 1 Basics of Sensors
- 2 Types of Sensors
- 3 Characteristics of Sensors
- 4 Sensor Analytics
- 5 Organizational

Overview

- 1 Basics of Sensors
- 2 Types of Sensors
- 3 Characteristics of Sensors
- 4 Sensor Analytics
- 5 Organizational

Learning Goals

- Understand the importance of sensors in autonomous mobile robotics & their working principles
- Distinguish the advantages & disadvantages of sensors
- Carry out basic analysis of sensor data

I. Basics of Sensors

Lecture Contents

- 1 Motivation — Why sensing in autonomous mobile robotics?
- 2 Definition — What is sensing? sensor?
- 3 Principle — How to sense?
- 4 Perception Vs Sensing — What sensing is not

1. Motivation — Why sensing in autonomous mobile robots?

- Robots use **knowledge** about the **world** to purposefully **act** on it
- There is **no prior complete knowledge** of the world
- The world **dynamics & constituents** are **not fully known**
- Therefore, **no pre-planning** possible



Unexpected wheel slip

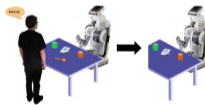

Unexpected spoon disappearance



Unexpected obstacle (wind)



2. Definition — What is sensing? sensor?

Sensor is a device that **senses** the world, i.e.

- **detects** a **physical phenomenon** (e.g. obstacle, light) in the world
- **measures** a physical quantity related to the phenomenon (e.g. distance, temperature, intensity)
- **converts (transduces)** the measurement into a suitable signal for processing (e.g. electrical, optical for electronic computers)

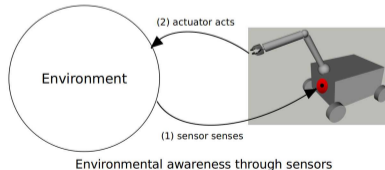

3. Principle — How to sense? (I)

Sensing occurs in three steps: **detection, measurement, conversion**

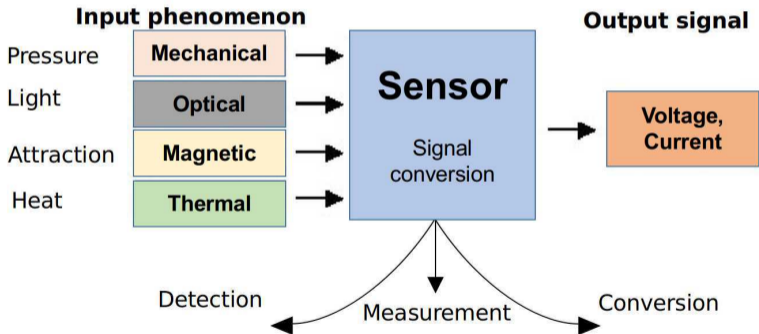

3. Principle — How to sense? (II)

Two ubiquitous sensors: SoNaR & LiDaR

SoNaR

- acoustic sensor
- detects obstacle
- by emitting sound and detecting reflection (echo)
- measures distance to obstacle (time of flight)

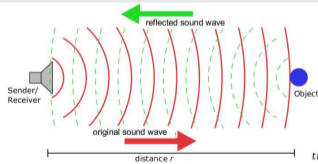
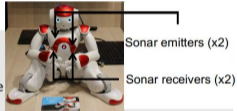

$$\text{time of wave flight} = \frac{\text{distance to obstacle}}{\text{speed of wave}}$$

LiDaR

- optical sensor
- detects obstacle
- by emitting light and detecting reflection
- measures distance to obstacle (time of flight)

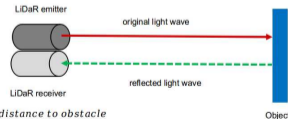

3. Principle — How to sense? (III)

LiDaR (Laser) — Light Detection and Ranging

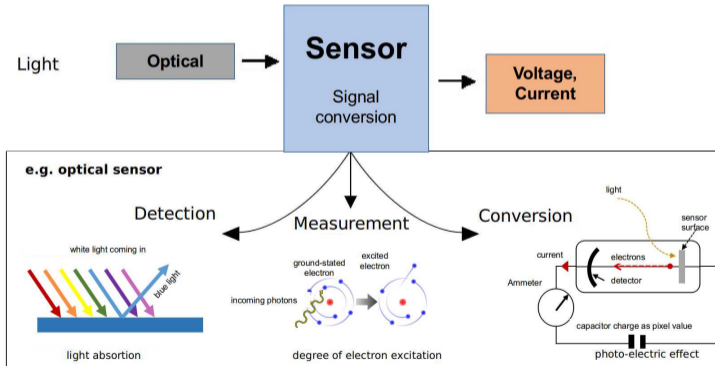

3. Principle — How to sense? (IV)

SoNaR — Sound Navigation and Ranging

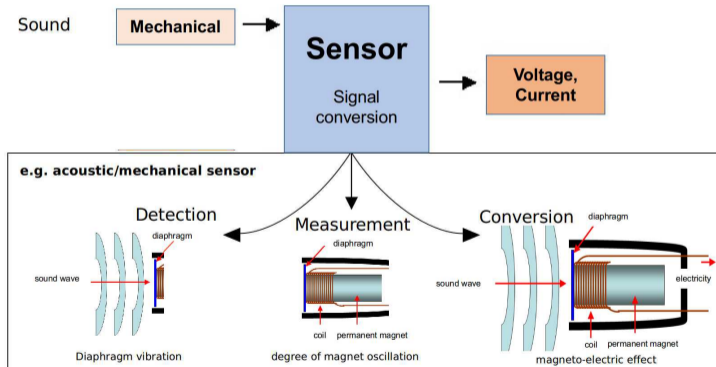

4. Perception Vs Sensing — What sensing is not

- Sensing is just the **earliest step in the measurement** of the world state
- Sensing is mainly about **collecting raw data** about the world state (e.g. camera shows **green area**, but **what is it?**)
- The full measurement of the world state is known as **perception**
- Perception = **Sensing + Data Interpretation** (e.g. green area is mug)



Sensor detects green, but what is it?

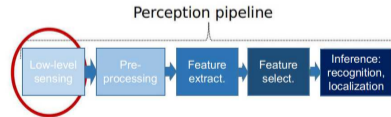

Sensing as earliest step of perception

Lecture Summary

In this chapter, we learned about **the roles of sensors in autonomous mobile robots and their working principles**. This involved:

- Explaining the **importance** of sensors in autonomous mobile robots
- Defining sensors
- Presenting the **general working principle** of sensors
- Identifying and describing **two ubiquitous sensors** in autonomous mobile robots (LiDaR and SoNaR)
- Presenting **detailed working principle** of sensors through LiDaR and SoNaR

Thank you for your attention

Literature

- 1 "CHAPTER 1: INTRODUCTION TO SENSORS." National Research Council. 1995. Expanding the Vision of Sensor Materials. Washington, DC: The National Academies Press. doi: 10.17226/4782
- 2 https://www.researchgate.net/publication/301166370_Sensing_and_Sensor_Fundamentals
- 3 <http://www.psych.purdue.edu/~willia55/120/6.S-PMM.pdf>
- 4 Correll N., Introduction to Autonomous Robots: Kinematics, Perception, Localization and Planning, Magellan Scientific, 2016

Overview

- 1 Basics of Sensors
- 2 Types of Sensors
- 3 Characteristics of Sensors
- 4 Sensor Analytics
- 5 Organizational

Lecture Contents

- 1 Proprioceptive Vs Exteroceptive
- 2 Active Vs Passive
- 3 Contact Vs Non-Contact
- 4 Optical, Mechanical, Acoustic, Electrical

1. Proprioceptive Vs Exteroceptive (I)

Proprioceptive sensors measure **mechanics-related internal states** of the robot

- **Inertial** sensors (e.g. accelerometer)
(acceleration, rotation, speed, position)
- **Force-Torque** sensors
(torque, force)
- **Joint angle** sensors (e.g. rotary encoder)
(joint angular position)

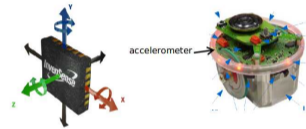

Images: (<https://industrial.panasonic.com/ww/products/sensors/sensors/6dof-inertial-sensor>);
(Bélangier-Barrette's Blog, 2020); (CONRAD)

1. Proprioceptive Vs Exteroceptive (II)

Exteroceptive sensors measure **external states** of the robot (surroundings)

- **Optical** sensors (e.g. camera)
(scene image, appearance)
- **Acoustic** sensors (e.g. microphone)
(sound)
- **Tactile** sensors
(pressure, texture, temperature)
- **Proximity** sensors (e.g. LiDaR, SoNaR)
(depth, obstacle, distance)



Images: (Evan-Amos); (CONRAD); (Hokuyo)

1. Proprioceptive Vs Exteroceptive (III)

Interoceptive sensors measure **feeling states** of the robot (e.g. hunger, fear, happiness, pains)

- still **uncommon** in robotics (**embryonic** research)
- **Battery** sensor (energy level)

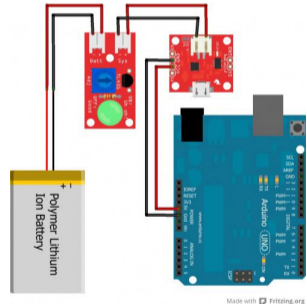

Equilibrioceptive sensors measure the **balance** of the robot body

2. Passive Vs Active

Exteroceptive sensors can be classified either as **active** or **passive**

- **Passive** sensors **only require energy** from phenomena for detection (e.g. most camera)

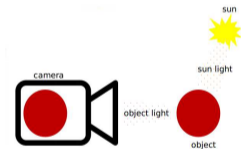

- **Active** sensors **emit energy** towards phenomena and detect **reflected energy** (e.g. LiDaR)

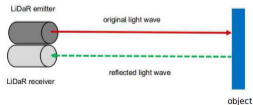

3. Contact Vs Non-Contact

Exteroceptive sensors can be classified either as **contact** or **non-contact**

- **Non-contact** sensors do not require any contact with energy sources for detection (e.g. most sensors)
- **Contact** sensors require contact with energy sources for detection (e.g. tactile sensors)

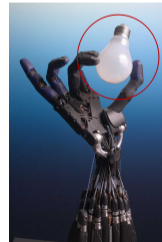
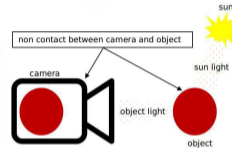

4. Optical, Mechanical, Acoustic, Electrical (I)

Optical sensors detect phenomena through **electromagnetic energy** (e.g. visible light, infrared, radiowaves, microwaves)

- **Camera** (visible light, appearance, depth loss)
- **LiDaR** (infrared, depth, indoor)
- **RaDaR** (radiowave, depth, outdoor)
- **GPS** (radiowave, 3D-position, outdoor)
- **Temperature sensor** (infrared, temperature)

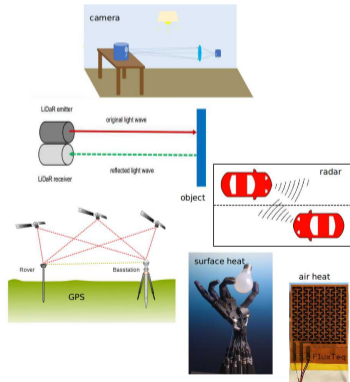

Images: (C.R. Nave, 2017); (Wikipedia RCraig09, 2009); (IAI Bremen, 2020); (G. Donald Allen, 2003); (ROMELa)

4. Optical, Mechanical, Acoustic, Electrical (II)

Mechanical sensors detect phenomena through **mechanical energy**

- **Force-Torque sensor** (force, torque)
- **Rotary Encoder** (joint angle)
- **Inertial sensor** (acceleration, rotation, speed)
- **Tactile sensor** (contact force/pressure)

Images: (Universal Robots); (AKM); (IAI Bremen, 2020); (University of Southern California)

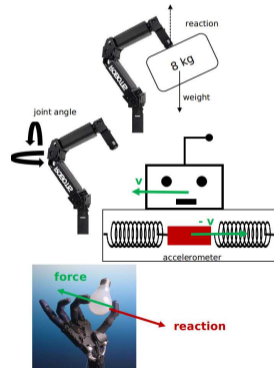

4. Optical, Mechanical, Acoustic, Electrical (III)

Acoustic sensors detect phenomena through acoustic energy (e.g. infrasound, sound, ultrasound)

- Microphone (sound, indoor)
- SoNaR (infrasound, ultrasound, depth, outdoor)

Images: (PJ Aviation, 2020); (Vinoj Appukuttan, 2018)

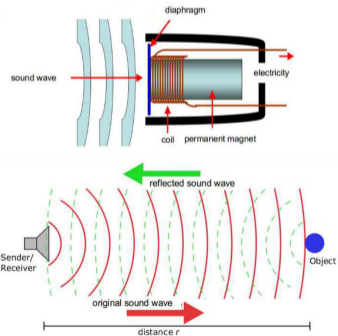

4. Optical, Mechanical, Acoustic, Electrical (IV)

Electrical sensors detect phenomena through electrical energy

- Battery sensor (energy level)

Images: (Praveen Dehari, 2018)

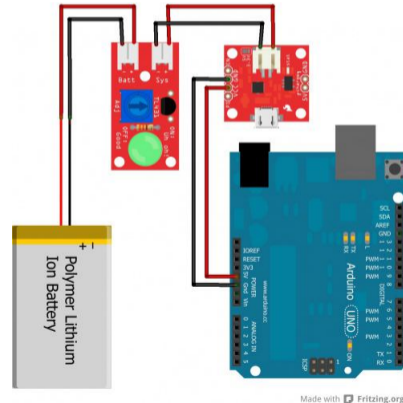

Lecture Summary

In this chapter, we learned how to **select a sensor for a given problem based on its function, the nature of its input, output and interaction with the world** . This involved:

- **Classifying sensors** w.r.t. to functions, inputs, outputs & interaction mode with the world
- **Identifying** at least one common sensor per class and **locating** it on the robot
- **Combining sensors** to achieve more information

Thank you for your attention

Literature

- 1 http://ee.sharif.edu/~industrialcontrol/Summary_Automation_Sensors_tutorial.pdf
- 2 <http://ijarse.com/images/fullpdf/160.pdf>
- 3 <http://www.cim.mcgill.ca/~yiannis/417/2013/LectureSlides/06-Sensors.pdf>
- 4 <http://robotics.sjtu.edu.cn/upload/course/5/files/Robot%20Sensors%20and%20Actuators-new.pdf>

Overview

- 1 Basics of Sensors
- 2 Types of Sensors
- 3 Characteristics of Sensors**
- 4 Sensor Analytics
- 5 Organizational

Lecture Contents

- 1 Range
- 2 Accuracy
- 3 Sensitivity
- 4 Precision
- 5 Resolution
- 6 Latency
- 7 Hysteresis (Deviation)

Motivation

- Sensors **detect**, **measure** and **convert** energy into electrical energy
- However, they can be **useless** under **circumstances** despite **functional capability**
- Sensor **characteristics** inform about the **expected quality** of collected data

1. Range

Is the **maximum** and **minimum** value **range** over which a sensor works well

- SoNaR (HC-SR04): **2 ~ 400cm**
- LiDaR (UTM-30LX): **10 ~ 3000cm**



Images: (Kuongshun Electronic); (Hokuyo)

2. Accuracy

Is the **degree of agreement** between the **measured (most likely)** and **"correct"** value

- SoNaR (HC-SR04): $\pm 0.035 \text{ cm/cm}$
- LiDaR (UTM-30LX): $10 \sim 1000 \text{ cm} : \pm 3 \text{ cm}, 1000 \sim 3000 \text{ cm} : \pm 5 \text{ cm}$

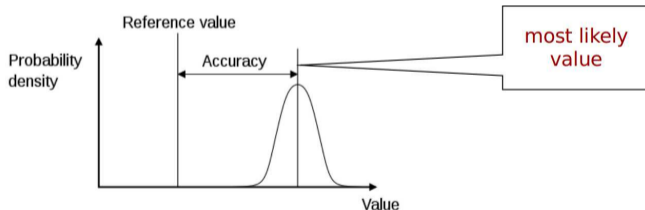

Images: (Wikipedia Pekaje, 2007); (IAI Bremen, 2020)

3. Sensitivity

Is how much the sensor output changes when the input changes

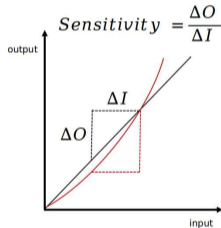

(a) Sensitivity

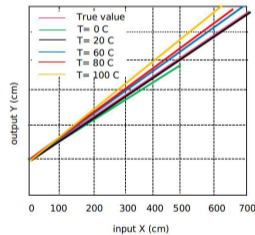

(b) HC-SR04 Sensitivity

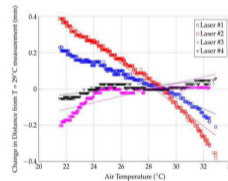

(c) Laser Sensitivity

Images: (Clíodhna Ni Scanail et al., 2013); (Abdusalam Al-Khwaji, 2016); (Matthew S. Kuester et al., 2018)

4. Precision / Repeatability / Stability

Is the **difference** between **repeated measures**

- SoNaR (HC-SR04): **0.1 ~ 0.5cm**
- LiDaR (UTM-30LX): **1 ~ 3cm**

Images: (*Wikipedia Pekaje, 2007*); (*IAI Bremen, 2020*)

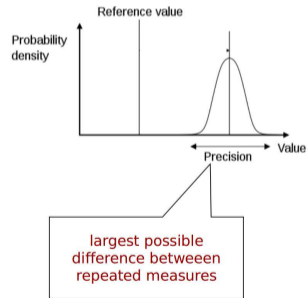

5. Resolution

Is the **smallest detectable change** in the phenomenon

- SoNaR (HC-SR04): $\approx 0.3\text{cm}$
- LiDaR (UTM-30LX): $\approx 0.1\text{cm}$

Images: (Tim Shotter, 2012)

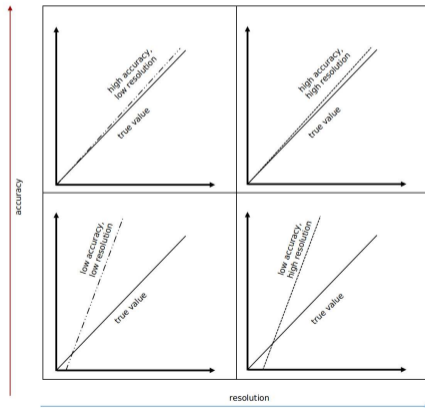

6. Latency

Is **time** required for a **change in input** to **cause a change in output**

- SoNaR (HC-SR04): $\approx 343m/s$
- LiDaR (UTM-30LX): $\approx 3 \times 10^8 m/s$

Images: (Monolithic Power Systems .Inc, 2020); (IAI Bremen, 2020)

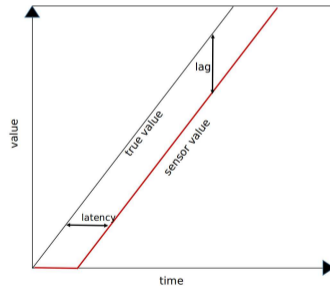

7. Hysteresis / Error / Deviation

Is the **maximum difference in output at different points** when measuring within the sensor's specified range with increasing and then with decreasing input

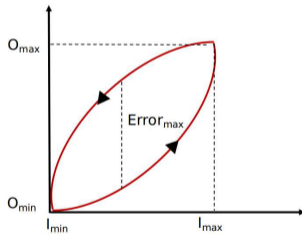

Sensor Hysteris

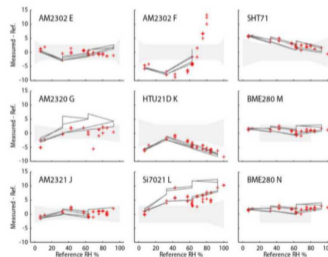

Hysteris comparision of Humidity sensors

Images: (Michael J. McGrath et al., 2014); (http://www.kandrsmith.org/RJS/Misc/Hygrometers/calib_many.html)

Lecture Summary

In this chapter, we learned how to **select a sensor for a given problem based on its properties**. This involved:

- **Identifying and defining the key properties** of sensors
- **Illustrating these properties by comparing** two ubiquitous sensors namely the LidaR and SoNaR sensors

Thank you for your attention

Literature

- 1 https://www.researchgate.net/publication/321625640_Sensor_Characteristics_Input_and_output_Characteristics
- 2 https://www.uni-frankfurt.de/72222368/20180529_sensors.pdf
- 3 <https://www.philadelphia.edu.jo/academics/kaubaidy/uploads/Sensor-Lect2.pdf>
- 4 https://faculty.weber.edu/snaik/ECE5900_ECE6900/02Lec02_SensorChar.pdf

Overview

- 1 Basics of Sensors
- 2 Types of Sensors
- 3 Characteristics of Sensors
- 4 Sensor Analytics**
- 5 Organizational

Lecture Contents

- 1 R(obot) O(perating) S(ystem) & Sensor Data
- 2 Sensor Noise
- 3 Sensor Model

1. R(obot) O(perating) S(ystem) & Sensor Data (I)

ROS is a platform that supports the development & execution of highly distributed robotic applications including the collection of data with sensors

- Install ROS
- Connect sensors to machine
- Download ROS-compatible sensor softwares from GitHub
- Run software on computer to collect data

Images: (Gaurav Gupta, 2019)

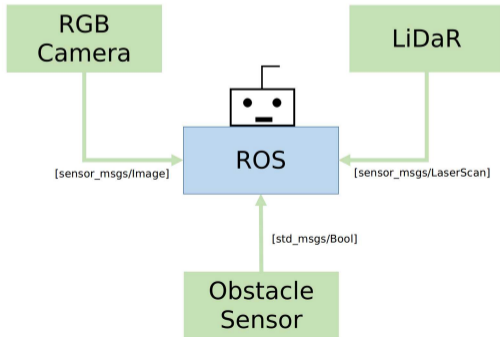

1. R(obot) O(perating) S(ystem) & Sensor Data (II)

Sensor data as streams of qualitative and quantitative values

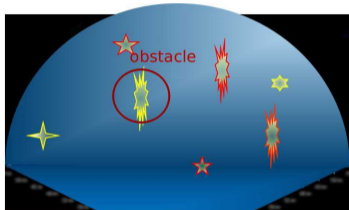

0.75	0.00	0.15	...
0.18	0.78	0.69	...
0.29	0.35	0.57	...
0.17	0.42	0.60	...
...

(a) SoNaR image

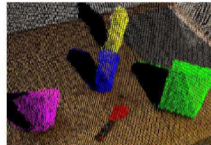

0.49	0.37	0.53	...
0.12	0.38	0.29	...
0.09	0.49	0.33	...
0.21	0.54	0.69	...
...

(b) LiDaR image

2. Sensor Noise (I)

- Sensor data are **extremely noisy**
 - Sensor **noise** characterizes **any undesirable (unwanted) quantity** in data/signal
 - Noise **corrupts frequency, amplitude and phase** of signal
 - Noise usually presents **random** aspects
- **Internal sources** of noise:
poor sensor characteristics, wrong parameterization, failure ...
 - **External sources** of noise:
signal interferences, disturbances, absorption, ...

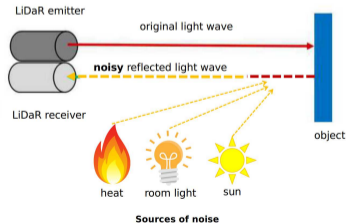

Images: (Abhilash Patel, 2020)

2. Sensor Noise (II)

Illustration of noise in sensor data

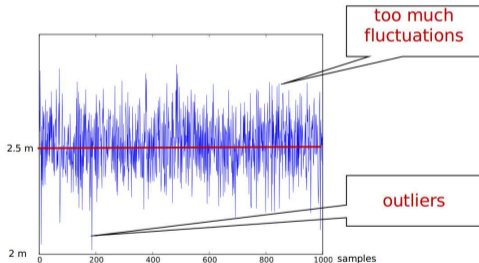

(a) SoNaR data, true value in red, measured value in blue

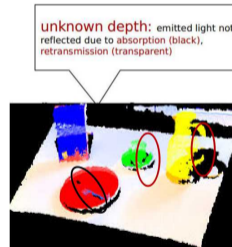

(b) LiDaR image with unknown values

Images: (IAI Bremen, 2020); (Ching-Tang Hsieh, 2015)

3. Sensor Model (I)

- Sensor **modeling** is a **mathematical attempt** to **describe noise** in sensor data
- General (**additive**) model: $y = f(x) + e(x)$, where
 - x , is the sensor input
 - y , is the sensor output
 - e , is the sensor error
 - f , is the sensor's ideal transduction function
- Sensor error **e quasi-impossible** to model **analytically** (random + unknown)
- e is modeled **probabilistically** through **statistical inference**

3. Sensor Model (II)

- Probability $p(e)$: how likely can error e occur in sensor output y ?
- Probability $p(e|x)$: how likely can e occur in y given input signal x ?
- Deduce $p(e)$ from $p(e|x)$: $p(e) = \sum_x p(e|x) \cdot p(x)$ (marginalization)
- Compute $p(e|x)$ or $p(e)$ through **statistical inference**, i.e.
 - **sample** sensor data y for sensor input x or various x
 - **check** how erroneous y
 - **infer** $p(e|x) \sim p(y|x)$ or $p(e)$

- e.g. how erroneous(e) is the measured distance (y) to an obstacle located at 4m (x) far from a LiDaR sensor?

Images: (IAI Bremen, 2020); (Ricardo Omar Chavez-Garcia, 2014)

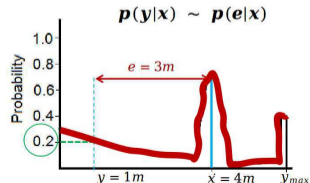

3. Sensor Model (III)

- **Statistical inference** of probabilistic function of noise $p(e)$ in SoNaR and LiDaR data
- $y^* = y - e^*$, is the **denoised** sensor output, e^* sampled w.r.t. $p(e)$

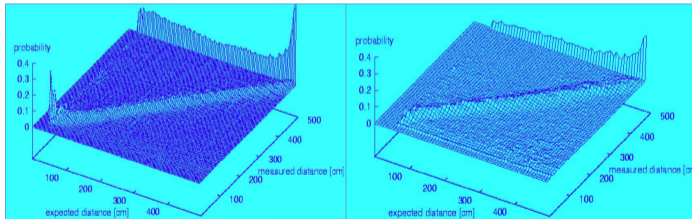

(a) LiDaR

probability density of
noise:

LiDaR is less noisy
than SoNaR

(b) SoNaR

3. Sensor Model (IV)

- Intuitively choose a **parameterized** probabilistic model for $p(e)$
e.g. gaussian distribution, $p(e) = \frac{1}{\sigma\sqrt{2\pi}} e^{-\frac{(e-\mu)^2}{2\sigma^2}}$
- Use collected data to estimate the parameters μ and σ
- Practical** parameter estimation **techniques**
e.g. gradient descent, genitic algorithms

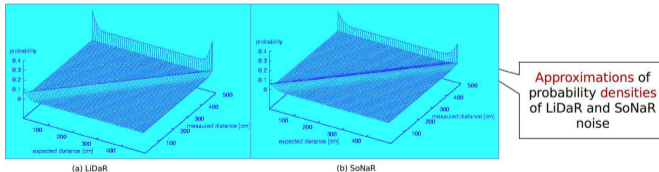

3. Sensor Model (V)

Other **common** denoising techniques

- **Low Pass Filtering**: filters out all high-frequencies from signal
- **High Pass Filtering**: filters out all low-frequencies from signal
- **Interpolation**: recovers missed measurements from neighboring measurements

Images: (Warren Weckesser, 2014); (NDT Resource Center); (Rafael Schultze-Kraft, 2017)

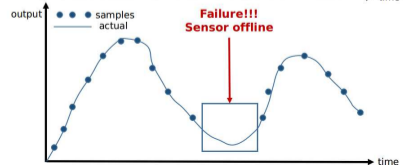
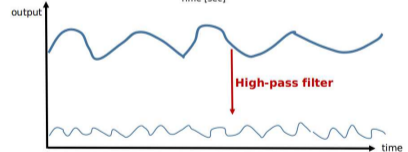
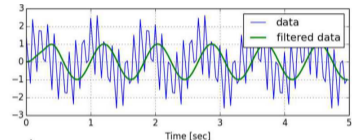

Lecture Summary

In this chapter, we learned how to **carry out basic analysis of sensor data**. This involved:

- **collecting data** from the robot world with sensors
- **criticizing the quality** of sensor data
- **explaining/justifying the quality** of sensor data
- **hypothesizing noise** in sensor data

Thank you for your attention

Literature

- 1 <http://wiki.ros.org/>
- 2 http://people.fisica.uniroma2.it/~solare/en/wp-content/uploads/2018/12/Lez_12_Noises.pdf
- 3 <https://www2.chemistry.msu.edu/courses/cem434/Chapter%205%20%20%20%20%20Signals%20and%20Noise.pdf>
- 4 <http://ais.informatik.uni-freiburg.de/teaching/ss11/robotics/slides/07-sensor-models.pdf>

Overview

- 1 Basics of Sensors
- 2 Types of Sensors
- 3 Characteristics of Sensors
- 4 Sensor Analytics
- 5 Organizational**

Assignment and dates

- Assignment 5:
<https://github.com/artnie/rpwr-assignments>
- Grades: 8 points for this assignment
- Due: 22.11., 23:59 AM German time
- Next class: 23.11., 14:00

Evaluation

Thanks for your attention!

Special thanks to the IAI team for the content of this lecture!

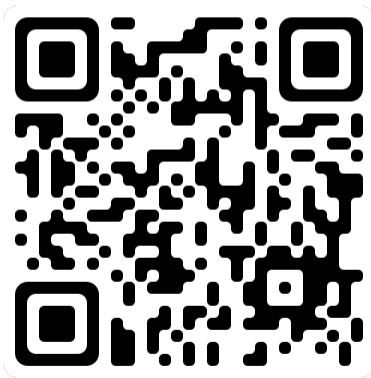

<https://forms.gle/iZyKqLCxsrwBU3XZ6>